

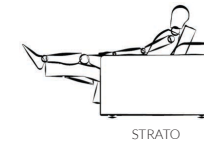

The right mechanism for you ... depends on preferred seating comfort & room layout.

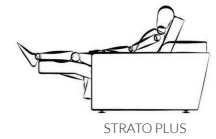

VS



FEATURES

- Heavy-duty steel frame mechanism featuring our dual motorized or relax function. The dual motors allow for the backrest and footrest to operate independently from one another to ensure maximum comfort for the user by fine-tuning their preferred seating position.
- Hand-crafted and ergonomically designed, using high-quality materials and high-density foam allows for maximum seating comfort for hours of movie and other viewing experiences.
- STRATO vs. STRATO PLUS – The difference is that STRATO PLUS offers an additional height in head support and an aesthetically pleasing slanted back.

UPHOLSTERY

A wide variety of luxurious leathers, exclusive designer fabrics or customer supplied upholstery (COM/COL). Our collection of luxury, top grain leathers and exclusive designer fabrics offer our customers a wide wide variety of upholstery options with endless colors, patterns, textures, etc. Perforation and embossing of leather is available upon request.

MODULARITY = CREATIVITY

Modularity allows for extensive flexibility and freedom to make up a perfect and unique seating layout that meets design and personal requirements. Like all CINEAK products, our STRATO seating is modularly built and consist of different elements such as seats and armrests in several standard or custom widths. With these elements, one can put together any preferred seating layout which perfectly fits your space.

Examples of possible layouts:

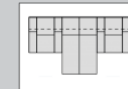
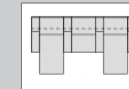

STRATO



MOTORIZED CHAISES



MOTORIZED SEATS



COMBINED UPHOLSTERY



LED backlit keypads

Control the motorized mechanism with programmable (light intensity, timer, etc.) features, which allows the user to have memory settings.

STRATO +

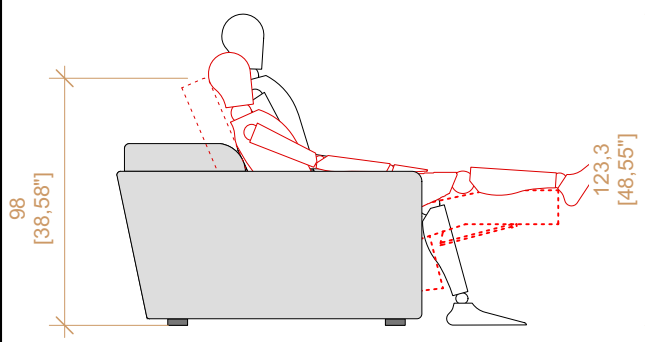

MOTORIZED

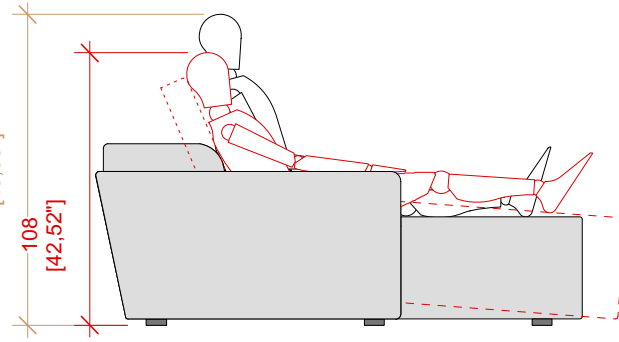

MOTORIZED CHAISE

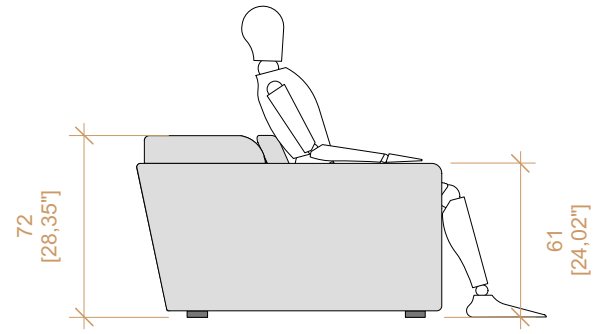

FIXED

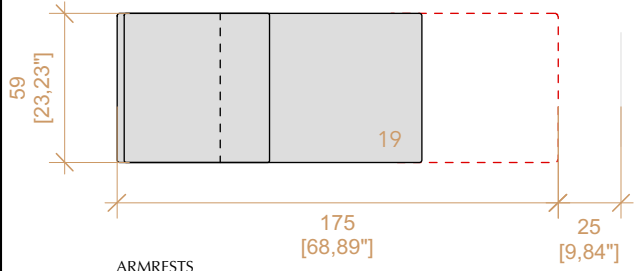
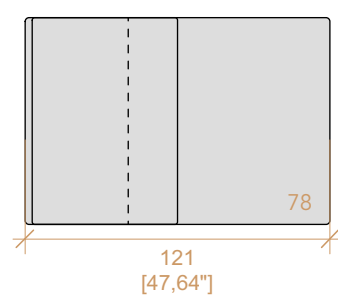
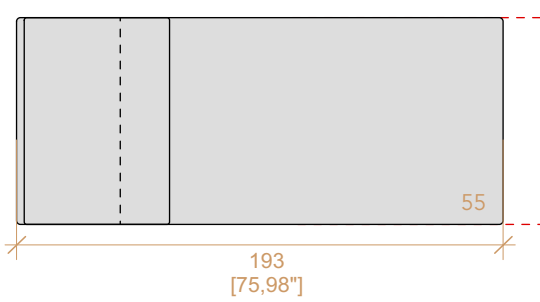
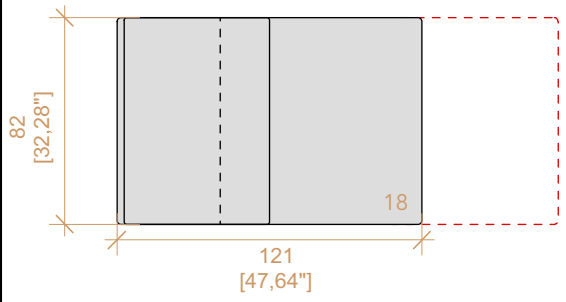

ARMRESTS

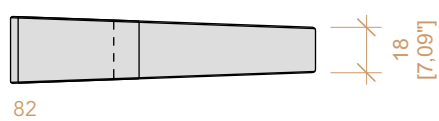
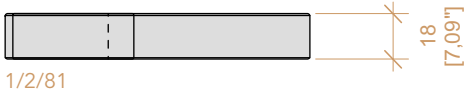
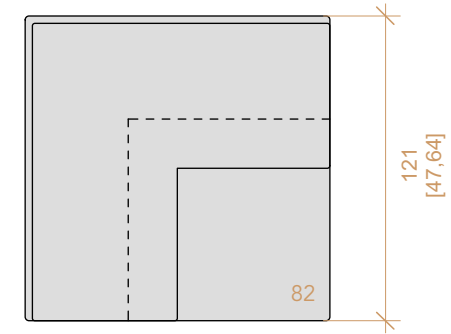
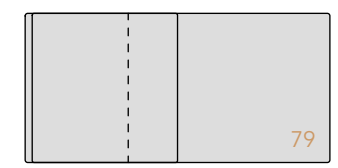
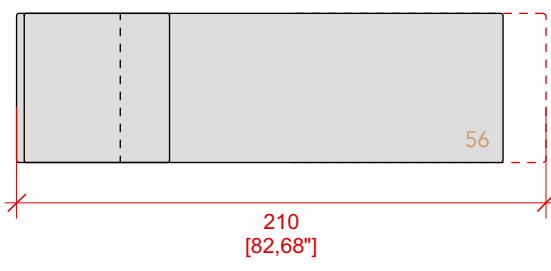

PROJECT: STRATO + V1.6
 Incliner, Chaise Armrests Plan & Elevation

Scale: 1/30 @ A4
 Date: April 21, 2016

Drawn by: KPH

Seating Layout by CINEAK. www.CINEAK.com. NOTE: All CINEAK products are custom made-to-order and hand-built - dimensions may vary and discrepancies will occur due to differences in foam thickness/density, covering materials, modularly adding seating parts and position of mechanisms. Allow small variances especially for modular configurations. CINEAK is NOT a room design nor acoustic-AY engineering firm. It is the responsibility of DEALER to verify dimensions, layout, specs and ALL aspects of seating to room - CINEAK does not take any responsibility nor can be held responsible for ANY issues other than quality and proper function of chairs manufactured to CINEAK standards. Dimensional information on products are estimates and may change over time. CINEAK suggests to verify dimensions at time of ordering.

STRATO

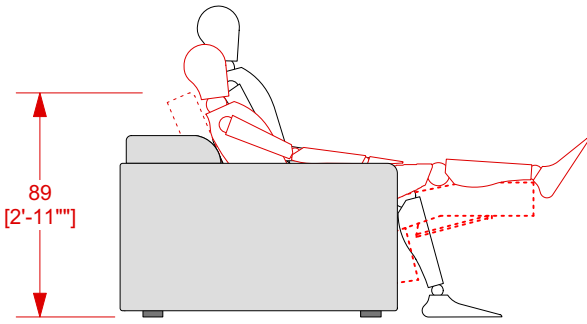

MOTORIZED

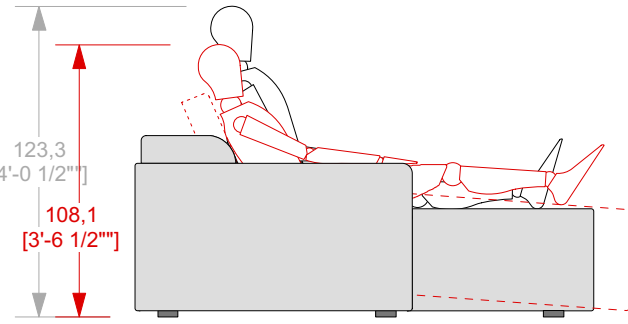

MOTORIZED CHAISE

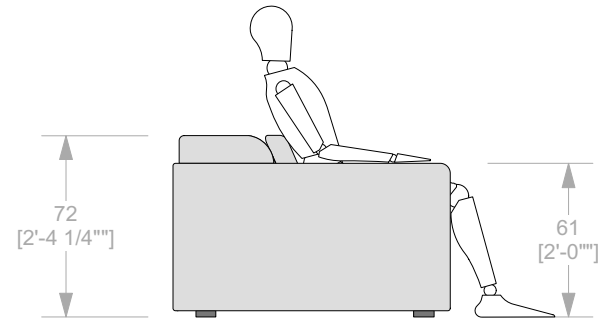

FIXED

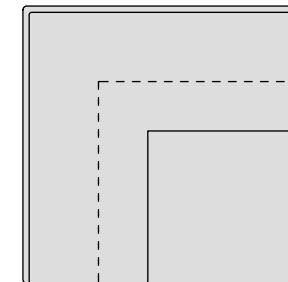
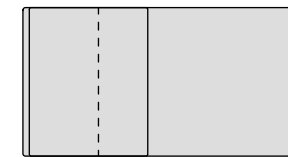
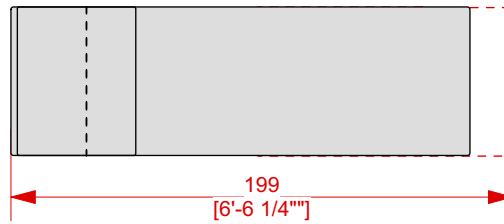
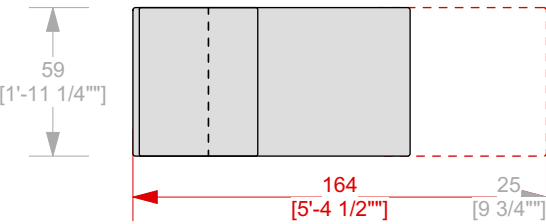
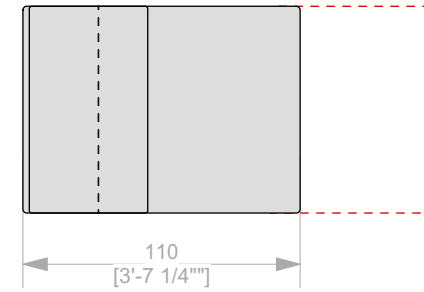
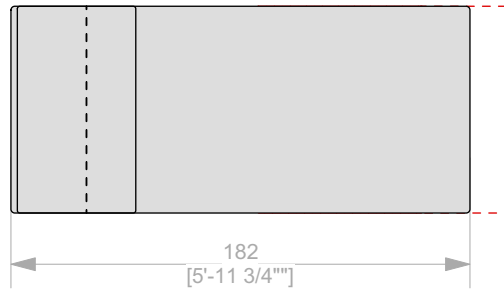
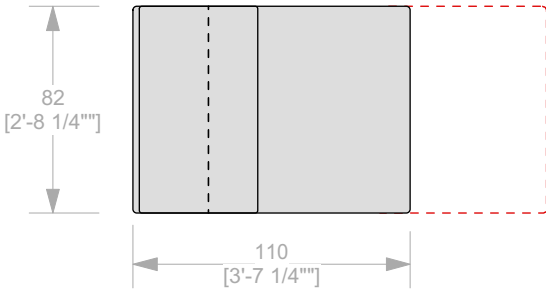

ARMRESTS

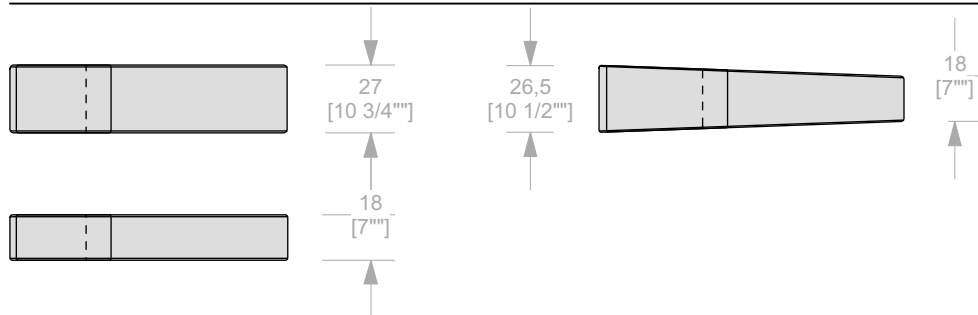

Drawn by:
KPH

Scale: 1/30 @ A4
Date: March 16, 2016

PROJECT: Strato V1.6
Incliner, Chaise & Arms Plan & Elevation view

Seating Layout by CINEAK, www.CINEAK.com NOTE: All CINEAK products are custom made to order and hand-built - dimensions may vary and discrepancies will occur due to differences in foam thickness/density, covering materials, modularly adding seating parts and position of mechanisms. Allow small variances-especially for modular configurations. CINEAK is NOT a room design nor acoustic AV engineering firm, it is the responsibility of DEALER to verify dimensions, layout specs and ALL aspects of seating to room - CINEAK does not take any responsibility nor can be held responsible for ANY issues other than quality and proper function of chairs manufactured to CINEAK standards. Dimensional information on products are estimates and may change over time. CINEAK suggests to verify dimensions at time of ordering.